

Tools:

Item	Tool Description
01	Cross Head 2PH (Philips Head No.2) Screwdriver.
02	(Metal) tape measure.
03	Mitre Box (if corners of SMARTFRAME to be mitred).
04	Fine toothed saw.
05	Marking knife/pencil.
06	Dia 4.5mm/5.0mm drill bit
07	Dia 3.5mm drill bit.
08	Drill.

SMARTFRAME

The SMARTFRAME kit is supplied with the components (the frame and 5 fixing screws per metre length) needed to secure the secondary glazing panel to your existing window frame. SMARTFRAME can accommodate 2mm or 4mm thick glazing including glass, acrylic or plate polycarbonate.

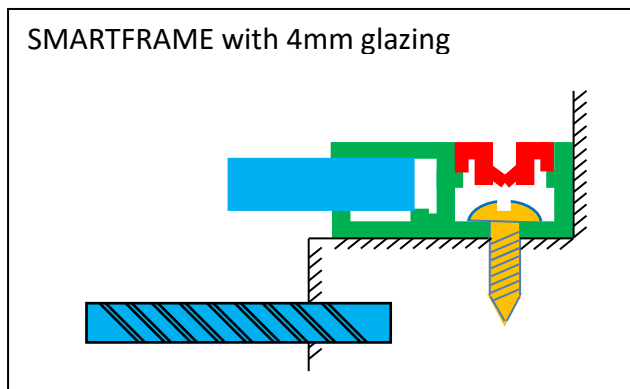
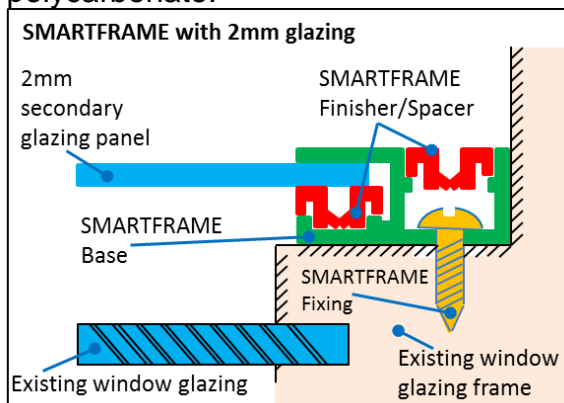

Installation

1. **SMARTFRAME component dimensions.**

Using a (metal) tape-measure measure dimension **A** (see adjacent diagram). Normally, the measurement is from the Left-Hand Window Reveal to the Right-Hand Window Reveal (with the tape-measure touching the existing window frame surface).

Sometimes the SMARTFRAME component is not required to abut the Window Reveal(s). In this case measure to where the outside edges of the SMARTFRAME are required.

Repeat this process for dimension **B**.

NOTE: The SMARTFRAME component is 22mm wide and requires 22mm of flat window frame to fit against.

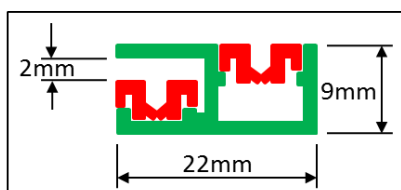
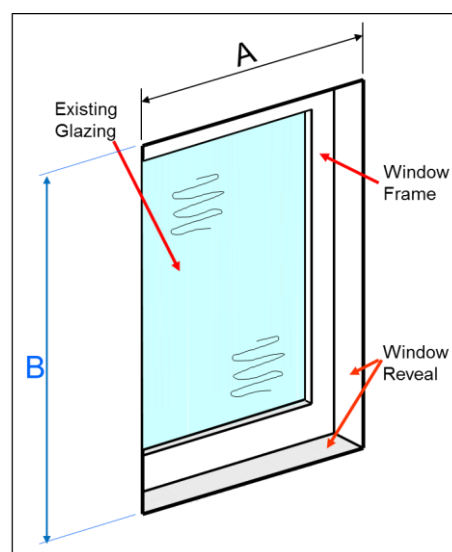

Measuring for the SMARTFRAME component dimensions (continued).

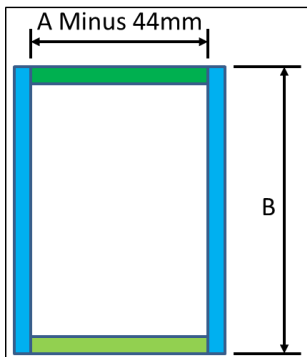

If SMARTFRAME components are to be BUTT joined at the corners:
Vertical components = Dim.B.
Horizontal components = Dim.A minus 44mm.

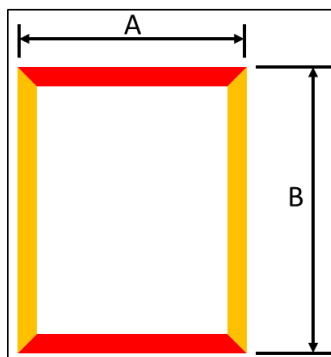

If SMARTFRAME components are to be MITRED at the corners:
Vertical components = Dim.B
Horizontal Components = Dim. A

The Glazing Panel Dimensions

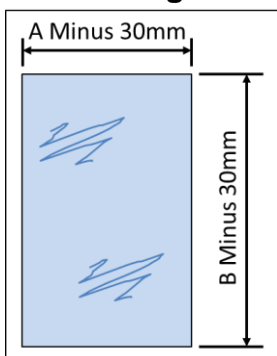

Glazing Panel Dimensions:
(A Minus 30mm) x (Minus 30mm)

2. Cut Mitres (if Mitres are being employed)

Mark the SMARTFRAME outer edge where the Mitre is to be cut (use dimensions A and B to locate the mark) with **Marking Knife/Pencil**. Cut the Mitres with **Fine Toothed Saw/Mitre Box**.

3. Prepare the SMARTFRAME components

Remove the finishing strips from the Base components that will cover the fixings when installed. Locate the SMARTFRAME components where they are to be fitted, marking where the screws are to be located, **Drill** the **4.5mm/5.0mm** clearance holes in the Base components (screws should be located close to the ends of the SMARTFRAME Base components and every 250mm) then mark and **Drill** the **3.5mm** pilot holes in the existing window frame.

Be sure that the SMARTFRAME Base components are located where required – this can best be achieved by (partially) securing all Base components in position prior to removal for final installation.

4. Installation of SMARTFRAME and Glazing Panel assembly

Insert the Glazing panel into the Base components. Present the assembly to the existing window frame. Secure the assembly in position by securing the fixings with a **Cross-head 2PH Screwdriver** nearest both ends of the SMARTFRAME Base components first of all. Secure remaining fixings. Fit the SMARTFRAME Finishing components to the Bases.

